

# Cutlass Fasteners, Inc.

83 Vermont Ave., Unit 6, Warwick, RI 02888  
Tel: (401) 732-6333 Fax: (401) 732-6336  
cutlass-studwelding.com

## Stud Welding...

- Fasteners
- Equipment
- Service

## PINTO MANUAL

**MODEL :** PINTO SYSTEM/PKM-1B GUN  
**PART NO. :** CSS-1K  
**SERIAL NO. :**



PLEASE READ THIS OPERATION AND MAINTENANCE MANUAL  
CAREFULLY BEFORE USING YOUR NEW CUTLASS STUD WELDER.

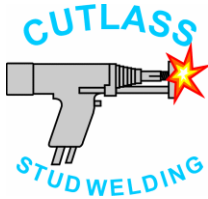

## Cutlass Fasteners, Inc.

83 Vermont Ave., Unit 6, Warwick, RI 02888  
Tel: (401) 732-6333 Fax: (401) 732-6336  
cutlass-studwelding.com

### Stud Welding...

- Fasteners
- Equipment
- Service

## PINTO MANUAL

### WARRANTY

The electrical and mechanical components of the Cutlass Stud Welders are thoroughly performance inspected prior to assembly in the Welder. The assembled Welder is completely performance checked. The Welder is delivered to you in perfect electro-mechanical condition. All parts used in the assembly of the Welder are fully warranted for a period of one year (365) days from the date of delivery.

Under this warranty, the manufacturer reserves the right to repair or replace, at its option, defective parts which fail during the warranty period. Notice of any claim for warranty repair or replacement must be furnished to the manufacturer, by the purchaser, within five (5) days after the defect is first discovered. The manufacturer does not assume any liability for paying shipping costs, or for any labor or material furnished where such costs are not expressly authorized in writing.

We do not warrant the Cutlass Stud Welders, parts or accessories against failures resulting from misuse, abuse, improper installation, normal wear and tear, maladjustment or use not in accordance with the operating instructions furnished by the manufacturer. Cutlass shall never be liable for any consequential damages.

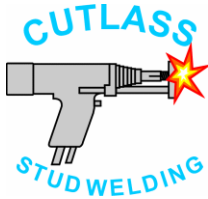

## Cutlass Fasteners, Inc.

83 Vermont Ave., Unit 6, Warwick, RI 02888  
Tel: (401) 732-6333 Fax: (401) 732-6336  
cutlass-studwelding.com

### Stud Welding...

- Fasteners
- Equipment
- Service

## PINTO MANUAL

### SUGGESTED SAFETY PRECAUTIONS

In any welding operation, it is the responsibility of the welder to observe certain safety rules to insure his personal safety and to protect those working near him.

Reference is directed without endorsement or recommendation, to ANSI Z49.1, Safety in Welding and Cutting, and to AWG Publication A6, 1-66 Recommended Safe Practices for Gas-Shielded Arc Welding.

1. Always treat electricity with respect. Under open circuit conditions, the welding machine output may be dangerous.
2. Do not work on live circuits and conductors. Disconnect the main power line before checking the machine or performing any maintenance operations.
3. Ensure the welding machine cabinet is properly grounded to a good electrical ground.
4. Do not stand in water or on damp floors while welding or weld in the rain. Avoid wearing wet or sweaty clothes when welding.
5. Do not operate with worn or poorly connected cables, and do not operate weld gun with loose cable connections. Inspect all cables frequently for insulation failures, exposed wires, loose connections and repair as needed.
6. Do not overload weld cables or continue to operate with hot cables.
7. Do not weld near flammable materials or liquids, in or near atmospheres, or on ducts carrying explosive gases.
8. Do not weld on containers which have held combustible or flammable materials, or on materials which give off flammable or toxic vapors when heated, without proper cleaning, purging, or inerting.
9. Ensure adequate ventilation is provided when welding in confined spaces.
10. Never look at the electrical arc without wearing eye shields.
11. Always use proper protective clothing, gloves etc. Never weld close to a bystander who is unaware of the possible dangers of ultraviolet light and weld splatter on their eyes.
12. Installation, servicing and trouble shooting should only be done by qualified personnel, familiar with this type of equipment.

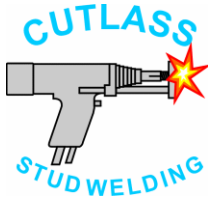

# Cutlass Fasteners, Inc.

83 Vermont Ave., Unit 6, Warwick, RI 02888  
Tel: (401) 732-6333 Fax: (401) 732-6336  
cutlass-studwelding.com

## Stud Welding...

- Fasteners
- Equipment
- Service

## PINTO MANUAL

### HOW TO INSTALL YOUR CUTLASS PINTO

1. Attach Ground Cable to workpiece with "C" clamp. Connect the other end of the cable to the (+) Positive socket on the Pinto.
2. Connect the Control Plug (3 pin connector) on the Gun cable, to the 3 Pin Socket on the front of the Pinto.
3. Connect the Weld Cable Plug on the Gun cable to the (-) Negative socket on the front of the Pinto.
4. Connect power lead to 120 volt supply.

**NOTE: UNIT IS SHIPPED FROM THE FACTORY TAPPED FOR 120 VOLT OPERATION. FOR 220/240 VOLT OPERATION THE TRANSFORMER MUST BE RE-TAPPED. SEE CIRCUIT DIAGRAM FOR CORRECT PROCEDURE.**

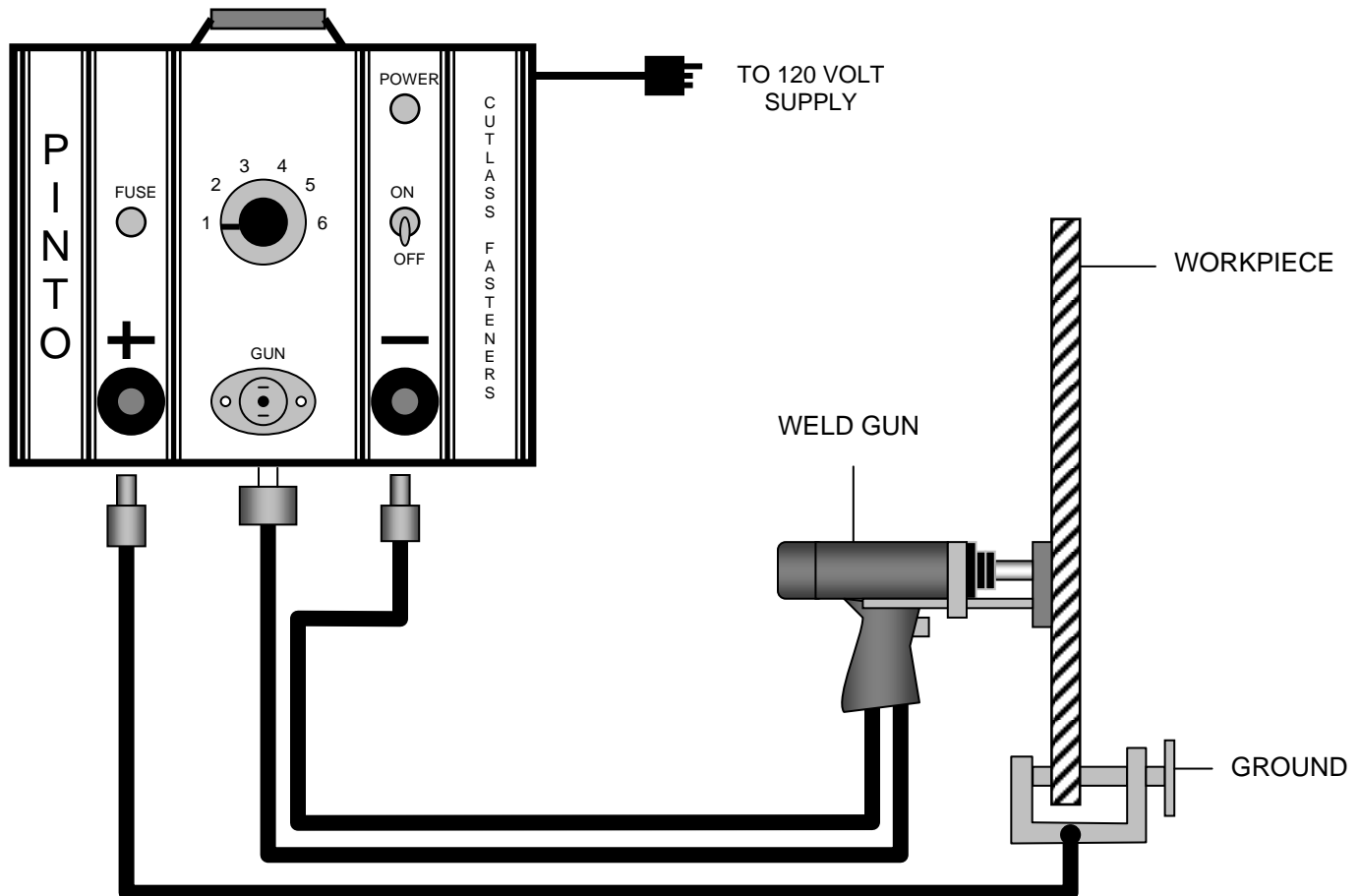

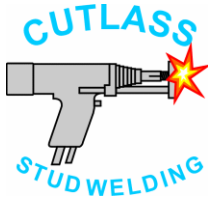

# Cutlass Fasteners, Inc.

83 Vermont Ave., Unit 6, Warwick, RI 02888  
 Tel: (401) 732-6333 Fax: (401) 732-6336  
 cutlass-studwelding.com

## Stud Welding...

- Fasteners
- Equipment
- Service

## PINTO MANUAL

The electrical and mechanical parameters of the weld are set using the voltage control knob on the front of the welder and by adjusting the spring pressure of the welding gun.

### ADJUSTING THE PKM-1B WELD GUN

The welding time depends on the speed of the stud as it moves forward into the molten welding pool. The speed is adjusted directly by changing the spring pressure. The greater the spring pressure, the shorter the welding time.

To adjust, use a coin or broad bladed screwdriver to turn the adjusting knob in the center of the back cap: Clockwise to increase spring pressure and Counterclockwise to reduce spring pressure. Set the spring pressure by observing the pointer in the window on the side of the weld gun. Do not force adjusting knob at limits of adjustment...damage to gun may occur if excess pressure is applied.

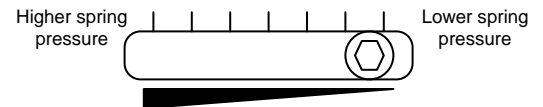
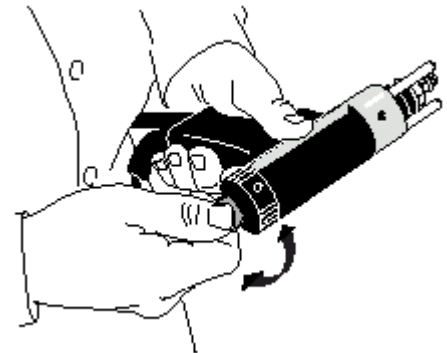

Exploded view of window scale on side of weld gun.

The gun is shipped from the factory in the 1-2 position. The suggested spring settings are shown below...

WORKPIECE MATERIAL	STUD MATERIAL AND DIAMETER														
	MILD STEEL **					STAINLESS STEEL					ALUMINUM ALLOY				
	#6	#8	#10	1/4	5/16	#6	#8	#10	1/4	5/16	#6	#8	#10	1/4	5/16
STEEL	1-2	1-2	1-2	1-2	1-2	1-2	1-2	1-2	1-2	1-2	-	-	-	-	-
STEEL GALVANIZED	1-2	1-2	1-2	1-2	-	1-2	1-2	1-2	1-2	1-2	-	-	-	-	-
STAINLESS STEEL	1-3	1-3	1-3	1-3	1-3	1-3	1-3	1-3	1-3	1-3	-	-	-	-	-
ALUMINUM ALLOY	-	-	-	-	-	-	-	-	-	-	4-6*	4-6*	4-6*	4-6*	-

\* Aluminum studs can be welded using the contact method with limitations

\*\* For Cupped Head Pins use spring setting at position #1

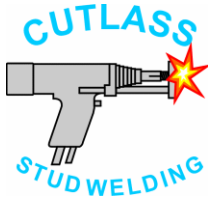

# Cutlass Fasteners, Inc.

83 Vermont Ave., Unit 6, Warwick, RI 02888  
 Tel: (401) 732-6333 Fax: (401) 732-6336  
 cutlass-studwelding.com

## Stud Welding...

- Fasteners
- Equipment
- Service

## PINTO MANUAL

### WELD GUN SETUP - threaded studs or pins

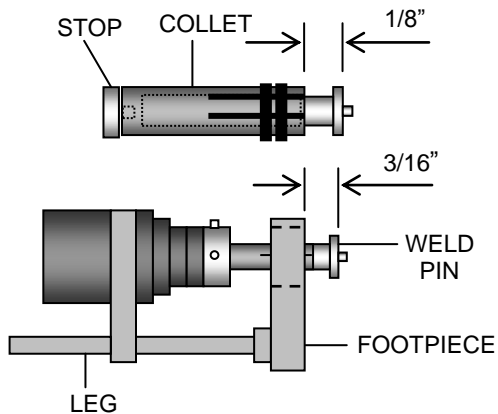

1. The weld collet and stop should be adjusted as shown. For longer pins, as much of the pin should be held as possible. A "button" stop is recommended for longer pins.
2. Seat weld collet in the front of weld gun and tighten the two socket screws. Attach leg and footpiece assembly. Set leg depth so approximately 3/16" of pin protrudes beyond the footpiece.

### WELD GUN SETUP - insulation pins

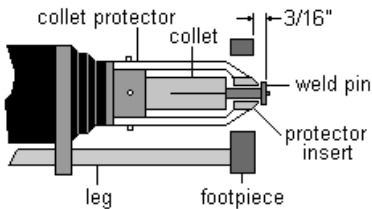

For standard weld pins up to 6" long

Assemble all accessories to gun as shown. Ensure front end of gun is centered through hole in footpiece and there is no binding of parts. Set protrusion of stud to approx. 3/16" so spring pressure will force stud into molten weld pool.

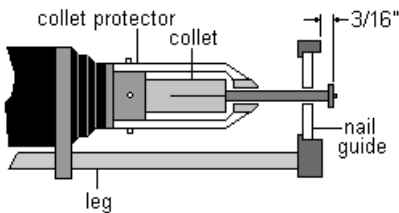

For all standard insulation pins over 6.1/2" long

Set up is as above except nail guide should be fitted to footpiece. Nail guide prevents long pins from bending or skidding during the weld. Again ensure pin is centered through nail guide and footpiece to prevent binding.

**MAKING THE WELD** - Place weld gun perpendicular to weld surface. Apply pressure to gun so footpiece lies firmly on the workpiece. Hold gun steady and pull trigger when stud is in required position. After weld cycle withdraw gun from stud. Pull gun straight back so weld chuck is not damaged. Inspect weld and adjust settings as required.

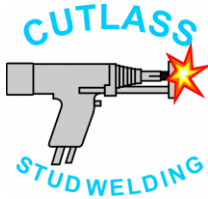

# Cutlass Fasteners, Inc.

83 Vermont Ave., Unit 6, Warwick, RI 02888  
 Tel: (401) 732-6333 Fax: (401) 732-6336  
 cutlass-studwelding.com

## Stud Welding...

- Fasteners
- Equipment
- Service

## PINTO MANUAL

### VOLTAGE CONTROL

A variable voltage control knob is mounted on the front panel of the unit. Before turning the power switch on, the voltage knob should be turned to full counter-clockwise position.

When the equipment is completely connected, turn the power switch to the "ON" position. The red power light will glow indicating power is supplied to the machine. Slowly turn the voltage control knob clockwise to increase power and set according to the recommendations below. The settings shown below are to be used as a guide only, and we recommend test welding on scrap material to ascertain optimum weld parameters for a specific application.

STUD MATERIAL	STUD SIZE	VOLTAGE SETTING	STUD POLARITY
MILD STEEL & STAINLESS STEEL	14GA	2-3	NEGATIVE
	12GA	3-4	
	10GA	4-5	
	3/16	5-6	
ALUMINUM	12GA	3-4	POSITIVE
	10GA	5-6	

### TEST WELDING

Before making your first weld, check the ground clamp. It is essential that no power be lost through a poor connection. The surface under the ground should be free from oil, scale, grease and rust. The test should be on a piece of scrap material similar to the material to be used during actual production.

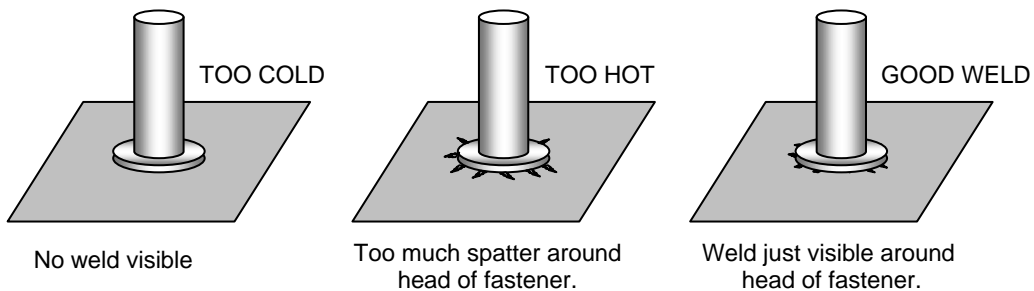

**NOTE: IF WELD APPEARS COLD, DO NOT PLACE GUN ON WELDED STUD AND TRIGGER AGAIN. DAMAGE TO WELD CHUCK OR CONTROLLER WILL OCCUR.**

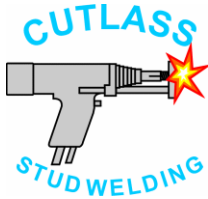

# Cutlass Fasteners, Inc.

83 Vermont Ave., Unit 6, Warwick, RI 02888  
 Tel: (401) 732-6333 Fax: (401) 732-6336  
 cutlass-studwelding.com

## Stud Welding...

- Fasteners
- Equipment
- Service

## PINTO MANUAL

### STANDARD ACCESSORIES

B COLLETS

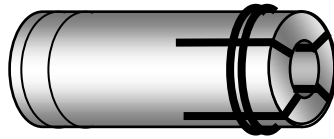

COLLET SIZE	PART NUMBER
14GA	669-232
12GA, #4	669-219
10GA, #6	669-220
3/16, #10	669-216

COLLET PROTECTOR

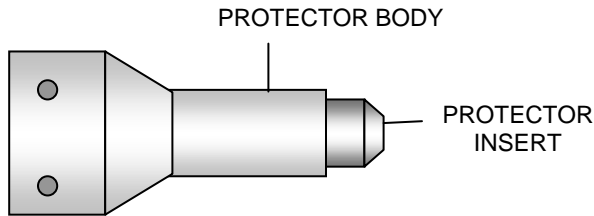

DESCRIPTION	PART NUMBER
BODY ONLY	028-836
12GA INSERT	028-834
10GA INSERT	028-835

FOOTPIECE

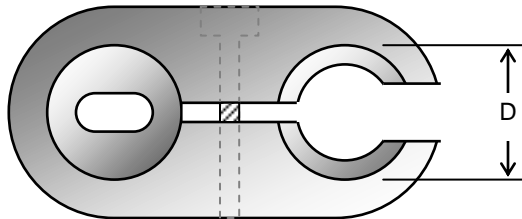

DESCRIPTION	PART NUMBER
FOOTPIECE S/L SMALL D=7/8"	023-252
FOOTPIECE S/L MEDIUM D=1.16"	023-252M

NAIL GUIDE

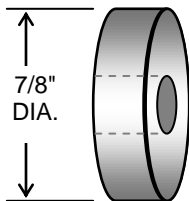

SPARK SHIELD

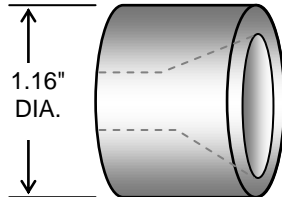

DESCRIPTION	PART NUMBER
NAIL GUIDE	601-350
SPARK SHIELD	999-013



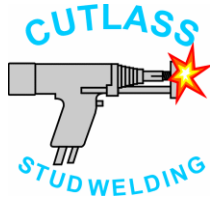

# Cutlass Fasteners, Inc.

83 Vermont Ave., Unit 6, Warwick, RI 02888  
Tel: (401) 732-6333 Fax: (401) 732-6336  
cutlass-studwelding.com

## Stud Welding...

- Fasteners
- Equipment
- Service

## PINTO MANUAL

### CAUSES OF POOR OR ERRATIC WELDS

1. Loose weld chuck – does not grip stud tightly.
2. Faulty or loose ground connection.
3. Dirty base material (oil, grease, rust etc.)
4. Voltage too high or too low.
5. Broken or loose cables.
6. Gun binding – dirt in weld gun preventing free movement.
7. Leg and/or footpiece incorrectly set.
8. Use of center punch.
9. Weld cables coiled.

**NOTE:** The weld cables and ground cables should be laid out in a straight line or large loops. Poor weld quality may result if welding cables are closely coiled.

### WELDER MAINTENANCE

Your Cutlass welder is designed for long service with minimum care. Ordinary common sense maintenance will keep it operating efficiently. Following are some tips on preventative maintenance:

1. Treat the welding and control cables with respect. Avoid sharp bends and kinks which may break cables. Do not use the cables as a "tow-line" to move the controller. Avoid damaging or straining the cables where they enter the gun or connectors.
2. Ensure unit vents are not obstructed, and that the unit is not covered while in use. Avoid overheating.
3. Keep the welding gun free of dust and dirt. Periodically clean weld splatter from front of gun.

### **WARNING!**

**THERE ARE NO USER SERVICEABLE PARTS INSIDE THE UNIT.**

**IF THE MACHINE MALFUNCTIONS, TURN THE MAIN SWITCH ON THE FRONT PANEL TO OFF, AND DISCONNECT THE UNIT FROM THE ELECTRICAL SUPPLY.**

**FOR FACTORY SERVICE OR THE NAME OF YOUR NEAREST QUALIFIED SERVICE FACILITY, CALL CUTLASS ON (401) 732-6333.**

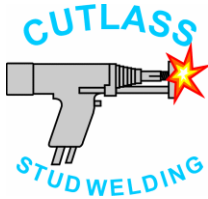

# Cutlass Fasteners, Inc.

83 Vermont Ave., Unit 6, Warwick, RI 02888  
 Tel: (401) 732-6333 Fax: (401) 732-6336  
 cutlass-studwelding.com

## Stud Welding...

- Fasteners
- Equipment
- Service

## PINTO MANUAL

### PKM-1B GUN PARTS

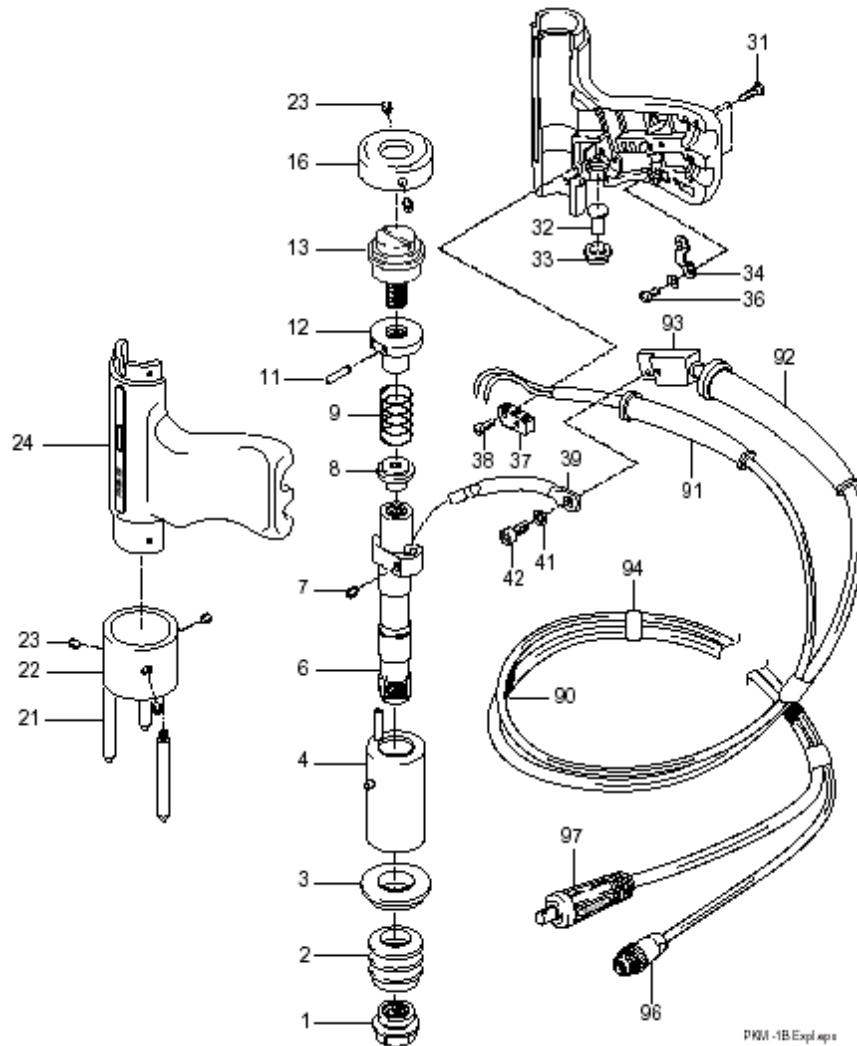

#### ALTERNATE PARTS...

ITEM	PART NO.	DESCRIPTION	QTY
1A	80-40-1738	TAPER CHUCK ADAPTOR	1
22A	80-40-1013	TROPOD FACEPLATE	1
22B	80-40-1113	TWIN LEG FACEPLATE	1

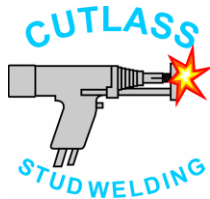

# Cutlass Fasteners, Inc.

83 Vermont Ave., Unit 6, Warwick, RI 02888  
 Tel: (401) 732-6333 Fax: (401) 732-6336  
 cutlass-studwelding.com

## Stud Welding...

- Fasteners
- Equipment
- Service

## PINTO MANUAL

### PKM-1B GUN PARTS

ITEM	PART NO.	DESCRIPTION	QTY
	PKM-1B-P25	COMPLETE PINTO PKM-1B	1
1	80-40-1741	B COLLET ADAPTOR	1
2	80-40-1097	BELLOWS	1
3	80-40-1023	INSULATING BUSH	1
4	80-40-1020	GUIDE BUSH	1
6	80-40-1740	SPINDLE	1
7	80-15-1011	M5 X 8 SOC. HD. SCREW	1
8	80-40-1027	SPRING PLATE	1
9	80-40-1031	MAIN SPRING	1
11	80-15-1022	M3 X 12 SOC. HD. SCREW	1
12	80-40-1015	ADJUSTING NUT	1
13	80-40-1603	SPRING ADJUSTING SCREW	1
16	80-40-1028	BACK CAP	1
21	80-40-1012	TRIPOD LEG	3
22	80-40-1739	SINGLE LEG FACEPLATE (fitted as standard)	1
23	80-15-1010	M5 X 4 SOC. HD. SCREW	1
24	80-40-1602	GUN BODY (TOP & BOTTOM)	1
31	80-10-1013	HANDLE SCREW	3
32	80-40-1016	TRIGGER BUTTON	1
33	80-40-1017	TRIGGER SLEEVE	1
34	80-10-1015	CABLE CLIP	1
36	80-15-1061	M2.5 X 8 SCREW	2
37	80-50-1013	TRIGGER SWITCH	1
38	80-15-1015	M2.0 X 10	2
39	80-72-1012	INTERNAL WELD CABLE	1
41	80-15-1016	M4 LOCK WASHER	1
42	80-15-1012	M4 X 8 SOC. HD. CAP SCREW 1	1
90	80-72-1039	WELD/CONTROL CABLE (16FT.)	1
91	80-10-1011	CONTROL CABLE SLEEVE	1
92	80-10-1013	WELD CABLE SLEEVE	1
93	80-35-1134	CABLE CONNECTING BLOCK	1
94	600-627	CABLE SLEEVE	1
96	000-594P	CONTROL PLUG C/M	1
97	000-573	WELD PLUG (Pinto Only)	1

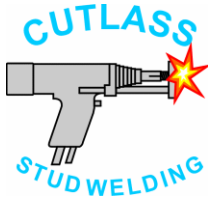

# Cutlass Fasteners, Inc.

83 Vermont Ave., Unit 6, Warwick, RI 02888  
 Tel: (401) 732-6333 Fax: (401) 732-6336  
 cutlass-studwelding.com

## Stud Welding...

- Fasteners
- Equipment
- Service

# PINTO MANUAL

## PINTO PARTS LIST

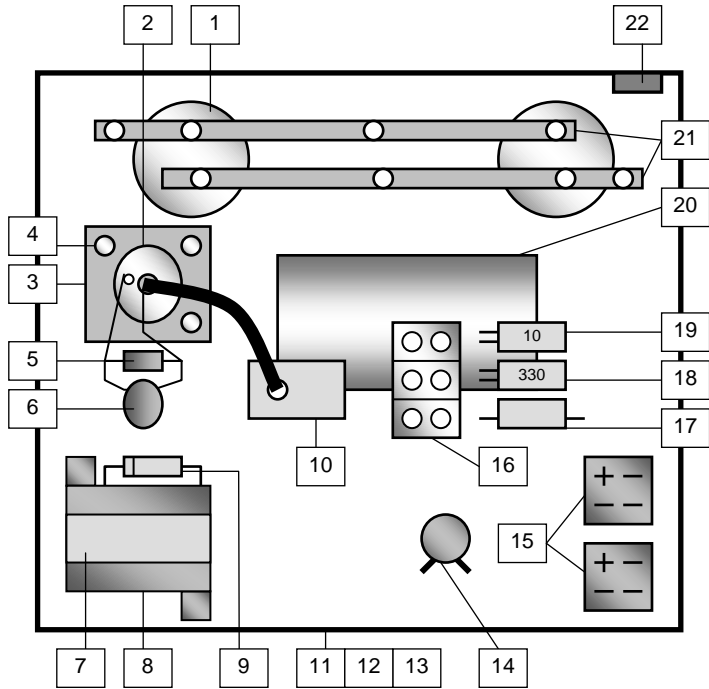

ITEM	DESCRIPTION	PART NO.
1	CAPACITOR (X2)	602-2299
2	WELD SCR	002-675
3	HEAT SINK	602-124
4	STAND OFF (X3)	602-125
5	RESISTOR 470R 1/2W	602-1055
6	CAPACITOR 0.1MFD	602-1056
7	RELAY 12VDC	602-1847
8	RELAY BASE	602-250
9	DIODE 1N4004	602-1054
10	CABLE MTG. BLOCK	602-1057
11	OUTER COVER	602-1043
12	CHASSIS	602-1042
13	FRONT PANEL	602-1025
14	DISCHARGE RESISTOR	002-984
15	BRIDGE RECTIFIER	019-592
16	TERMINAL BLOCK (X3)	002-480
17	RESISTOR 10K 1W	602-1030
18	CAPACITOR 330MFD	999-102
19	CAPACITOR 10MFD 63V	602-1029
20	MAIN TRANSFORMER	602-1026A
21	BUSS BAR STD	018-838
22	STRAIN RELIEF	018-700
23	POWER CORD & PLUG	999-090
24	CIRCUIT BREAKER 6A	602-1094
25	FRONT FACIA	602-1872A
26	WELD SOCKET (x2)	000-574
27	6-WAY SWITCH	602-1028
28	POT. KNOB	600-657P
29	CONTROL SOCKET	000-598P
30	ON/OFF SWITCH	602-050
31	NEON 110V	602-047
32	HANDLE	602-1163
33*	WIRE HARNESS	602-1050A

FRONT PANEL, FRONT VIEW

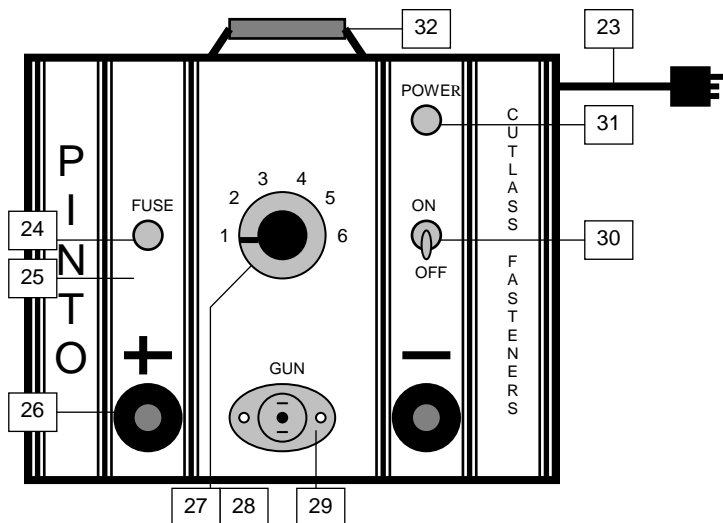

\*NOT SHOWN

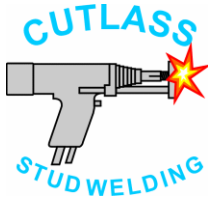

# Cutlass Fasteners, Inc.

83 Vermont Ave., Unit 6, Warwick, RI 02888

Tel: (401) 732-6333 Fax: (401) 732-6336

cutlass-studwelding.com

## Stud Welding...

- Fasteners
- Equipment
- Service

## PINTO MANUAL

### PINTO WIRING DIAGRAM

#### CHASSIS, TOP VIEW

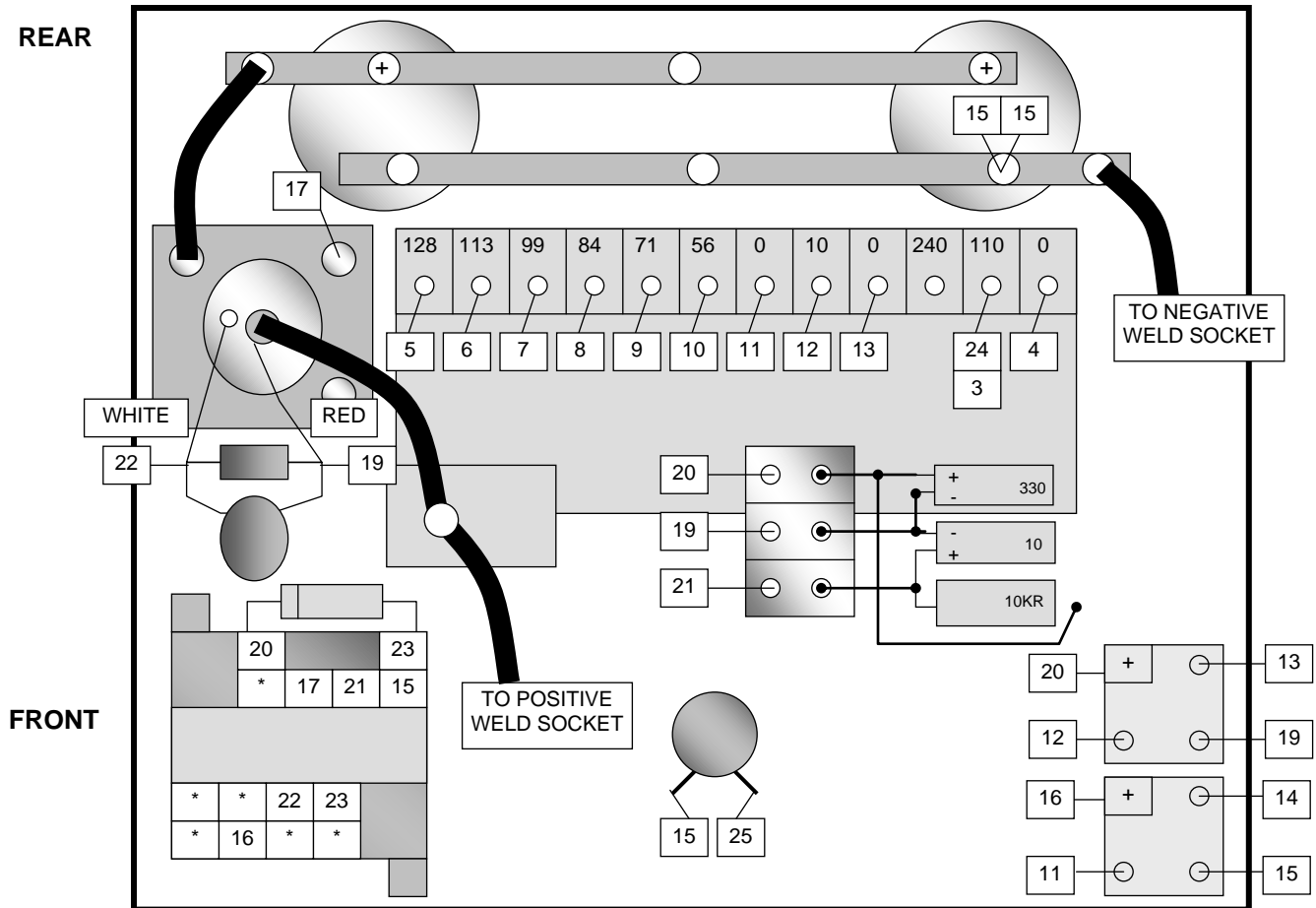

#### FRONT PANEL, REAR VIEW

